

4

3

2

1

### BILL OF MATERIAL (CURRENT LEVEL)

ITEM	PT/ASSY	DESCRIPTION	TYPE	QTY.
1	BM9	CLEAR ADHESIVE BACKED BUMPER	PART	4
2	64_292D	MIRROR GLASS	PART	1
3	MTM-003	MIRROR VERTICAL CHANNEL	PART	2
4	MTM-002	MOUNTING KIT	ASSEMBLY	1
5	92398	SCRW, M5 X .8 X 8 PHIL PAN HD Zn PLATED (MMC# 92005A318)	PART	8
6	2841T	TIE ROD	PART	2
7	40459	TRIM PLATE	PART	2
8	91462	VHB TAPE 1" X 1 1/2" LONG	PART	4

1 LOCATION FOR VHB TAPE

2 APPLY PLAMER MIRROR MASTIC

3 APPLY LOCTITE 680.

D

D

C

C

B

B

A

A

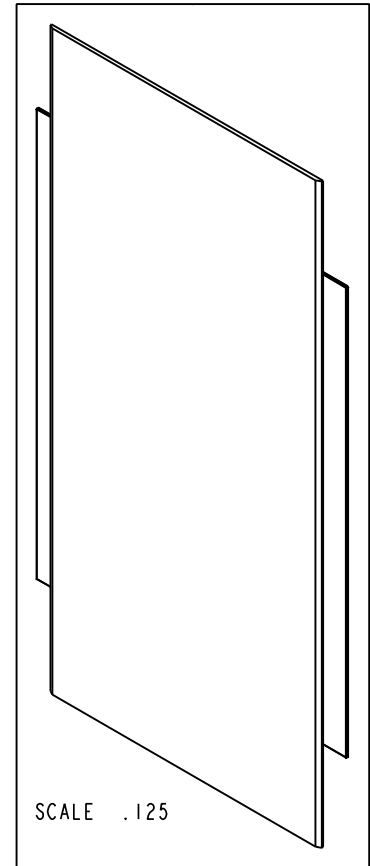
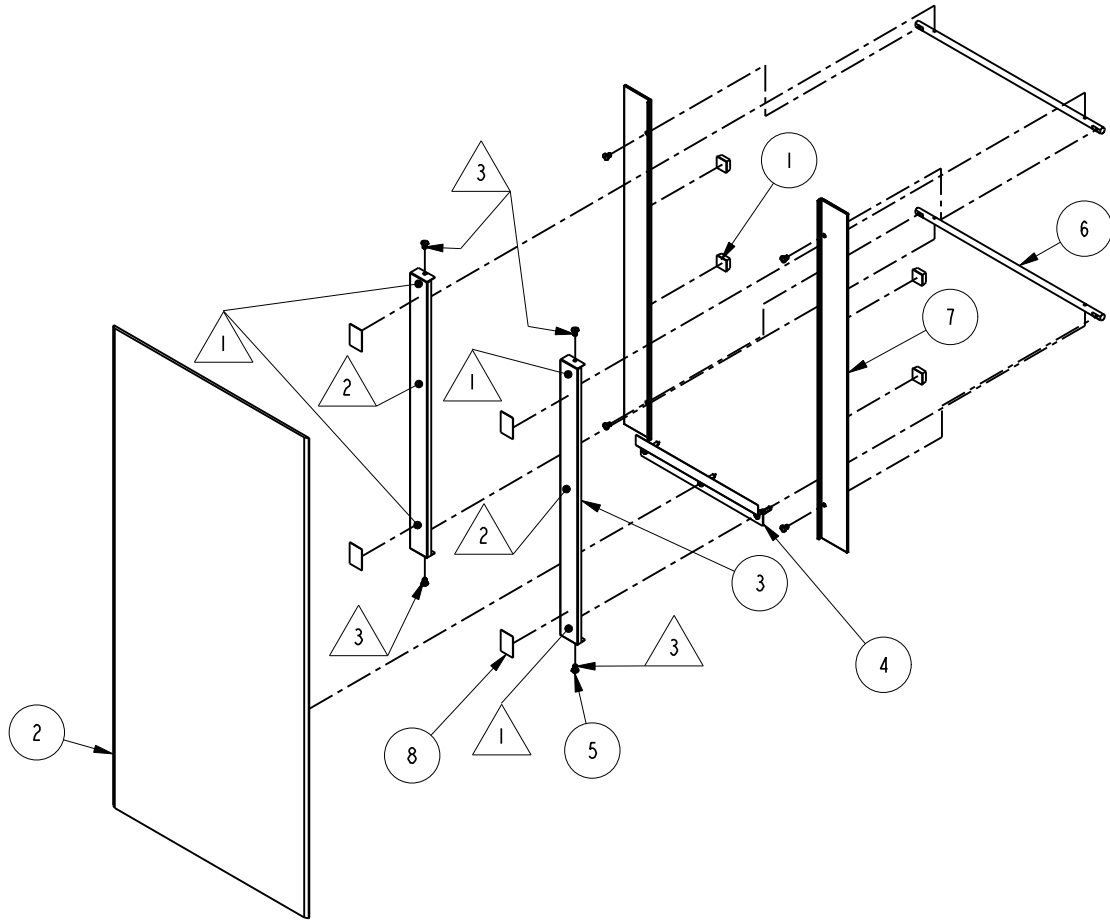

COPYRIGHT 2005 GINGER. THESE DRAWINGS AND THE DESIGNS DEPICTED HEREIN ARE THE PROPRIETARY PROPERTY OF GINGER. ANY USE OR REPRODUCTION IS SUBJECT TO THE EXPRESS APPROVAL OF GINGER. UNAUTHORIZED USE IS STRICTLY PROHIBITED. ALL RIGHTS RESERVED.

**GINGER**

2001 E. CARNEGIE AVE.  
SANTA ANNA CA 92705  
(949) 417-5207

SURFACE FRAMELESS BEVELED MIRROR

ASSY. NO. 2841

SCALE .090

REF.

SHEET 1 OF 3

D	EN-2148	04/30/12
C	EN-1974	11/21/11
B	EN-1949	11/03/11
A	EN-1465	02/12/10
REV	REV DESC	DATE

4

3

2

1

**SPECIFICATION DWG**

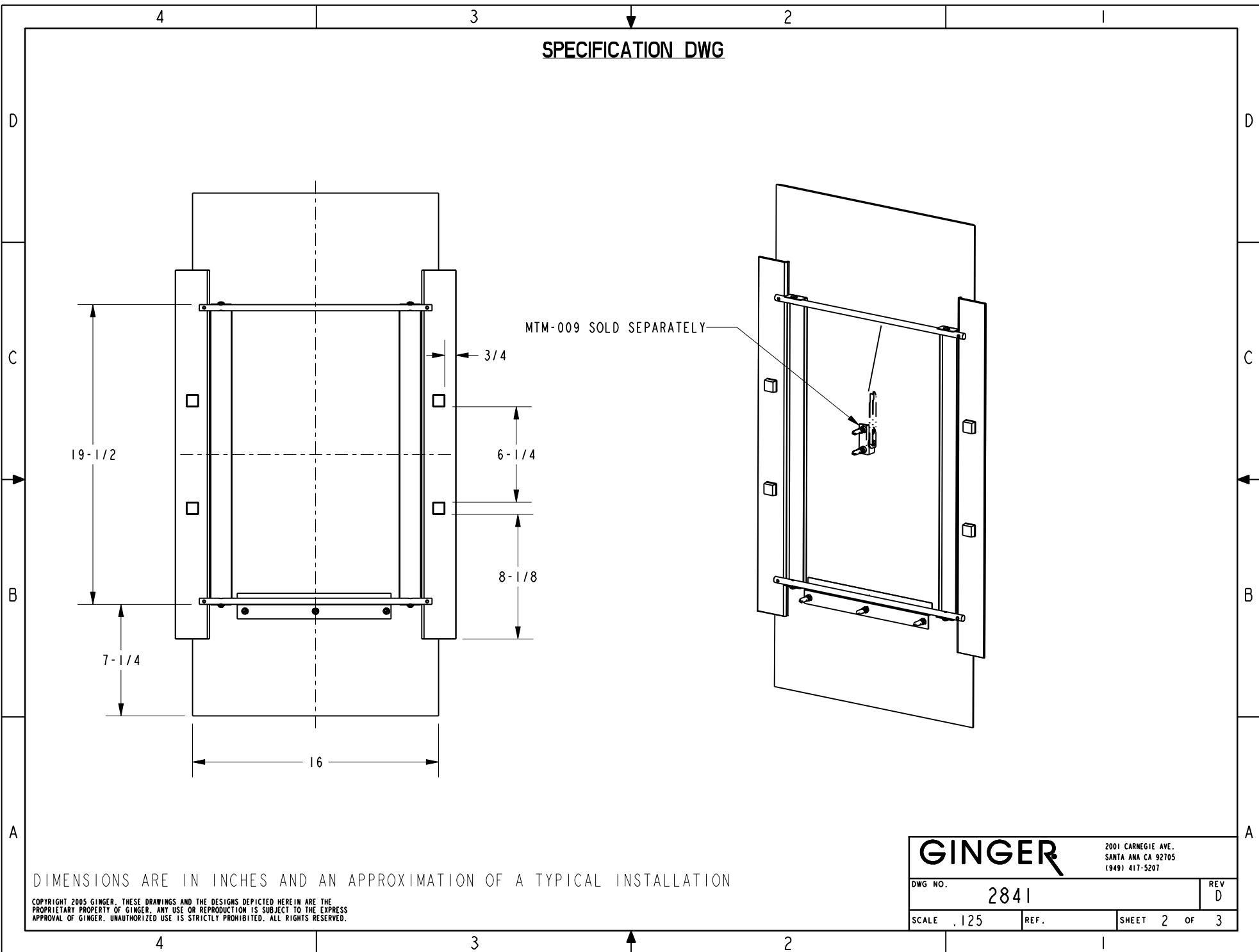

DIMENSIONS ARE IN INCHES AND AN APPROXIMATION OF A TYPICAL INSTALLATION

COPYRIGHT 2005 GINGER. THESE DRAWINGS AND THE DESIGNS DEPICTED HEREIN ARE THE PROPRIETARY PROPERTY OF GINGER. ANY USE OR REPRODUCTION IS SUBJECT TO THE EXPRESS APPROVAL OF GINGER. UNAUTHORIZED USE IS STRICTLY PROHIBITED. ALL RIGHTS RESERVED.

<b>GINGER</b>		2001 CARNEGIE AVE. SANTA ANA CA 92705 (949) 417-5207	
		DWG NO. 2841	REV D
SCALE .125	REF.	SHEET 2 OF 3	

**SPECIFICATION DWG**

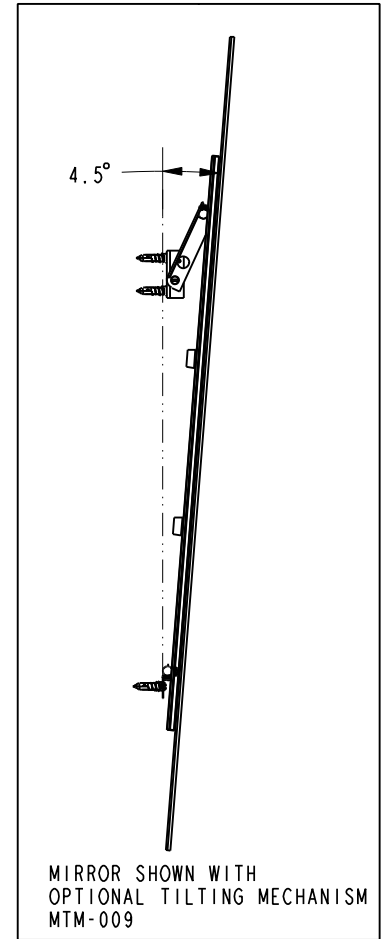
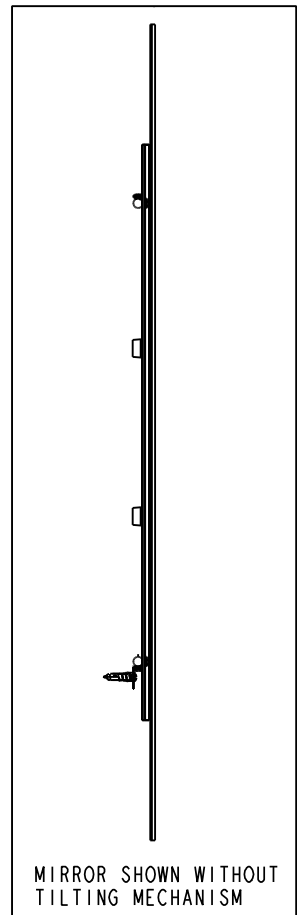
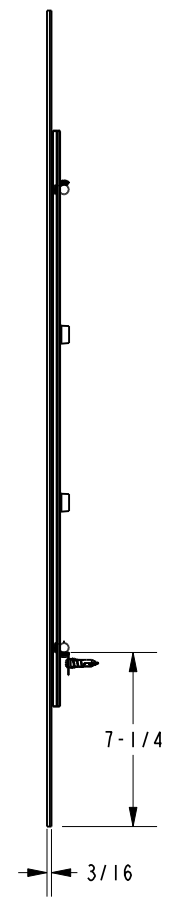
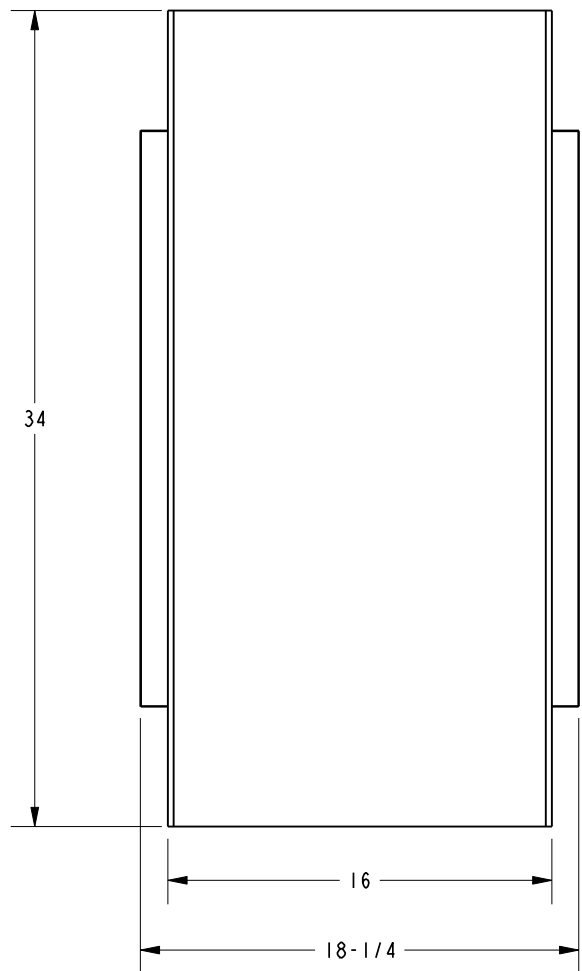
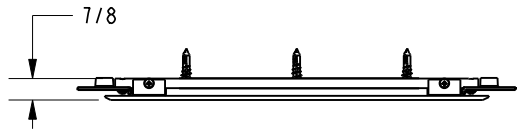

DIMENSIONS ARE IN INCHES AND AN APPROXIMATION OF A TYPICAL INSTALLATION

COPYRIGHT 2005 GINGER. THESE DRAWINGS AND THE DESIGNS DEPICTED HEREIN ARE THE PROPRIETARY PROPERTY OF GINGER. ANY USE OR REPRODUCTION IS SUBJECT TO THE EXPRESS APPROVAL OF GINGER. UNAUTHORIZED USE IS STRICTLY PROHIBITED. ALL RIGHTS RESERVED.

<b>GINGER</b>		2001 CARNEGIE AVE. SANTA ANA CA 92705 (949) 417-5207	
DWG NO.	2841	REV	D
SCALE	.125	REF.	SHEET 3 OF 3