

Features

- Single-speed whirlpool offers performance and value, with 8 fully adjustable jets.
- Hydromassage flow and direction can be controlled at each jet.
- Comfort Depth® design offers a convenient 19-inch step-over height while retaining the same depth as a standard 21-inch bath.
- Generous 6-foot length provides an incredibly spacious bathing area.
- Molded lumbar support offers extra comfort while bathing.
- Slotted overflow allows for deep soaking.
- Textured bottom surface
- Reversible drain.
- Coordinates with other products in the Archer collection.

Material

- Acrylic

Hydrotherapy

- Whirlpool

Installation

- Drop-in

Additional Hydrotherapy Options

- Soaking Bath - K-1125-0
- Soaking Bath + Bask heated surface - K-1125-W1
- BubbleMassage air bath - K-1124-G
- BubbleMassage air bath + Bask heated surface - K-1124-GW
- VibrAcoustic - K-1124-VB
- VibrAcoustic + Bask heated surface - K-1124-VBW
- Whirlpool - K-1124-0
- Whirlpool + heater - K-1124-H
- Whirlpool + Bask heated surface - K-1124-W1
- Whirlpool + BubbleMassage air bath - K-1124-XHG

Required Products/Accessories

K-7271 Brass Slotted Overflow Bath Drain

or

K-7272 PVC Slotted Overflow Bath Drain

Recommended Products/Accessories

K-9529 Removable Bath Seat

K-24916 Wireless Music Kit

K-1491 Bath/Whirlpool Pillow

K-1601 Bath/Whirlpool Footstop



ADA

Codes/Standards

ASME A112.19.7/CSA B45.10

CSA B45.5/IAPMO Z124

ASTM E162

ASTM E662

UL 1795

ADA

ICC/ANSI A117.1











**KOHLER® Plastic Baths and Receptors
Lifetime Limited Warranty**

**KOHLER® Hydrotherapy Components
Five-Year Limited Warranty**

See website for detailed warranty information.

Available Colors/Finishes

Color tiles intended for reference only.

Color	Code	Description
	0	White
	96	Biscuit
	47	Almond
	NY	Dune
	95	Ice™ Grey
	G9	Sandbar
	33	Mexican Sand™
	K4	Cashmere
	58	Thunder™ Grey
	7	Black Black™

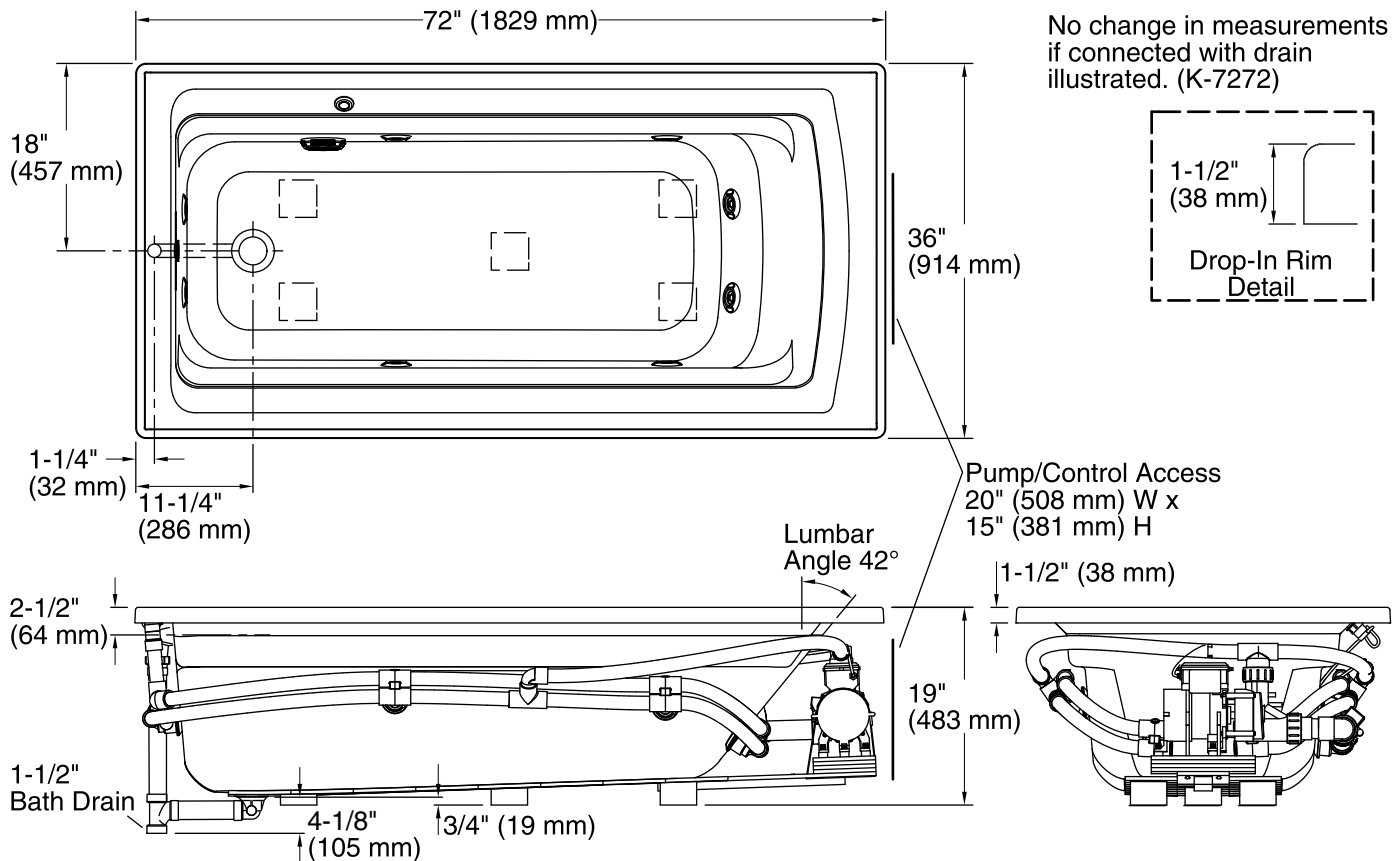

Required Electrical Service

One dedicated circuit required, protected with Class A Ground-Fault Circuit-Interrupter (GFCI). Outside North America, this device may be known as a Residual Current Device (RCD).

Pump: 120 V, 15 A, 60 Hz

Technical Information

All product dimensions are nominal.

Installation:	Drop-in
Drain location:	End
Basin area, bottom:	51-3/8" x 21" (1305 mm x 533 mm)
Basin area, top:	64-1/2" x 30-1/2" (1638 mm x 775 mm)
Weight:	110 lbs (49.9 kg)
Minimum floor load:	41 lbs/ft ² (200.2 kg/m ²)
Water depth:	15" (381 mm)
Water capacity:	72 gal (272.5 L)
Cutout:	Drop-in, 70-1/2" x 34-1/2" (1791 mm x 876 mm)
Electrical component rating:	Pump: 120 V, 7 A, 60 Hz
Minimum flat for door:	1-9/16" (40 mm)

Notes

Measure your actual product for rough-in details. Install this product according to the installation instructions.

The hot water supply should be 70% of the capacity of the bath or greater. Installations will vary.

This product is designed for drop-in installation only. It is not suited for use in a three-wall alcove with an overhead shower.

ADA compliant when installed to the specific requirements of these regulations.